

Rectangular prism - volume & surface area

Grade 6 Geometry Worksheet

Find the volume and surface area.

1.

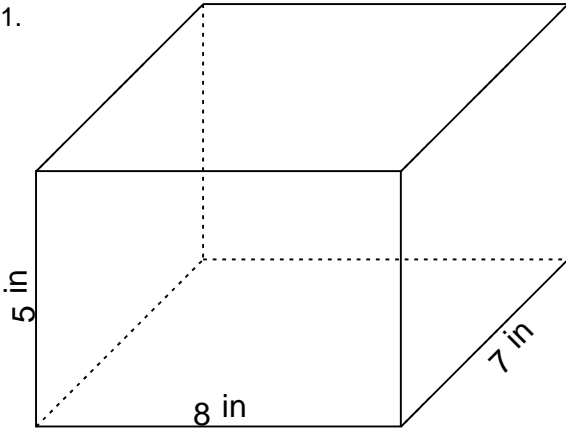

2.

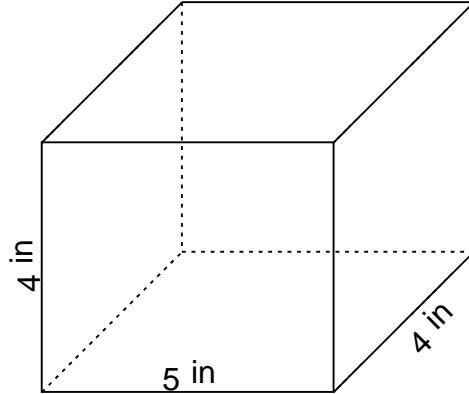

3.

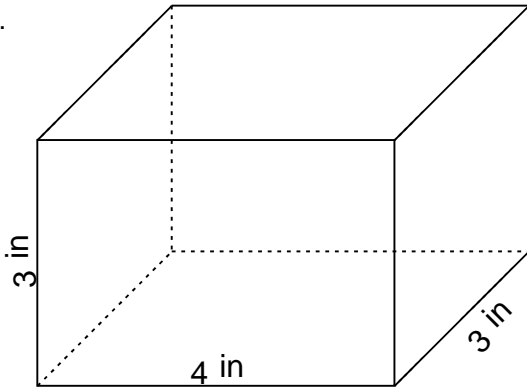

4.

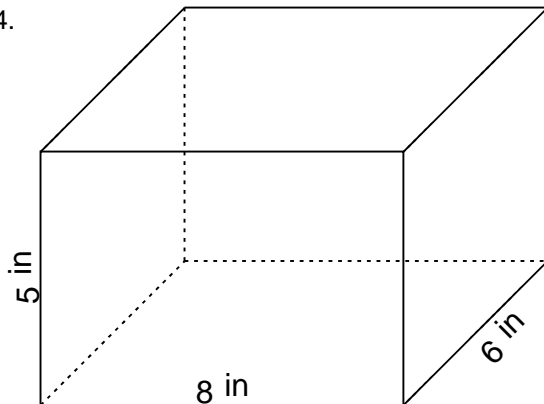

Rectangular prism - volume & surface area

Grade 6 Geometry Worksheet

Find the volume and surface area.

1.

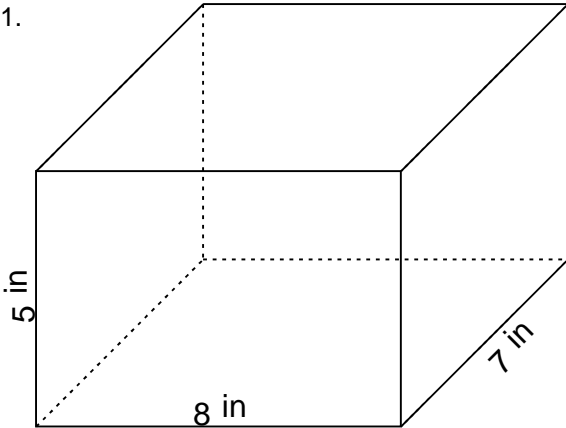

$$V = 280 \text{ in}^3 \quad SA = 262 \text{ in}^2$$

2.

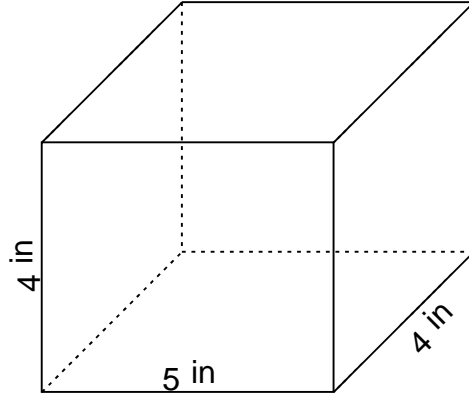

$$V = 80 \text{ in}^3 \quad SA = 112 \text{ in}^2$$

3.

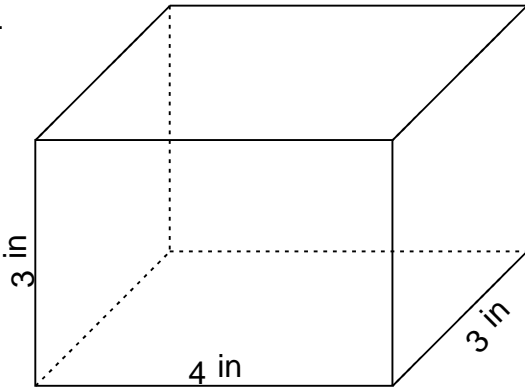

$$V = 36 \text{ in}^3 \quad SA = 66 \text{ in}^2$$

4.

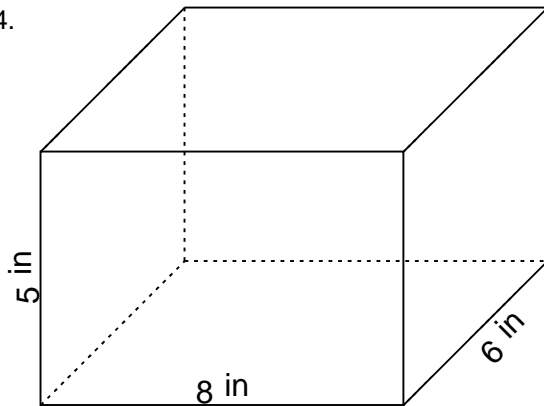

$$V = 240 \text{ in}^3 \quad SA = 236 \text{ in}^2$$