

Rectangular prism - volume & surface area

Grade 5 Geometry Worksheet

Find the volume and surface area.

1.

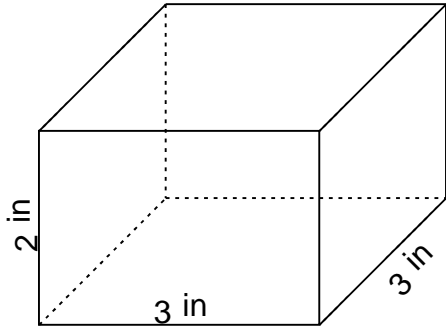

2.

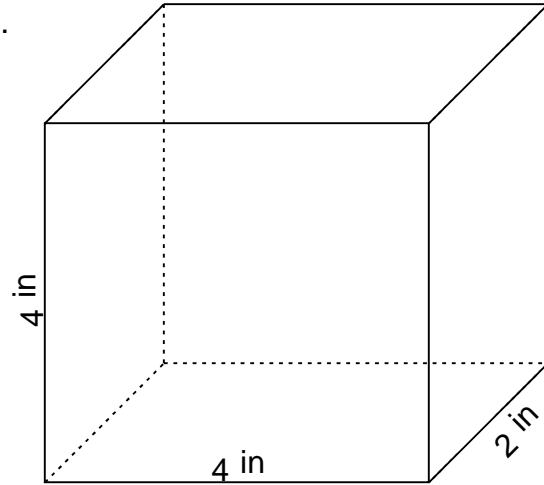

3.

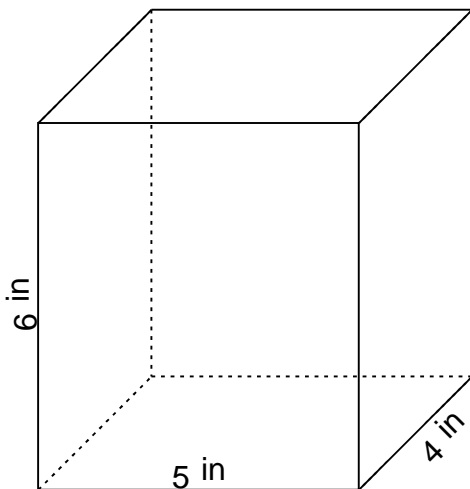

4.

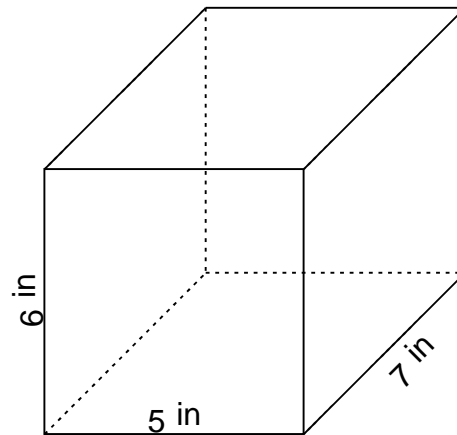

Rectangular prism - volume & surface area

Grade 5 Geometry Worksheet

Find the volume and surface area.

1.

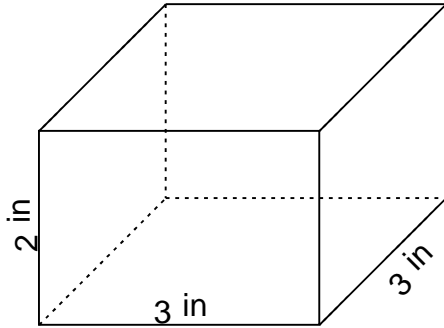

$$V = 18 \text{ in}^3 \quad SA = 42 \text{ in}^2$$

2.

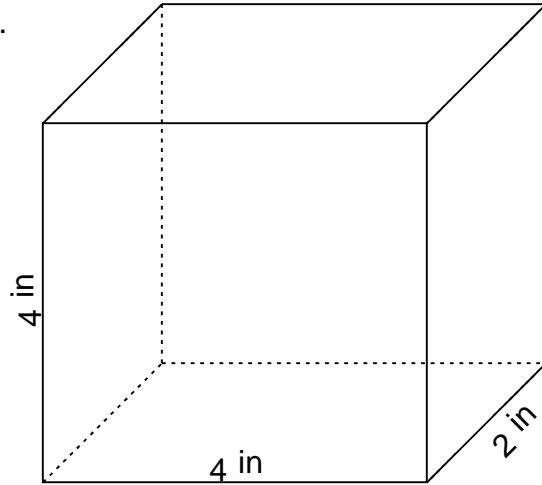

$$V = 32 \text{ in}^3 \quad SA = 64 \text{ in}^2$$

3.

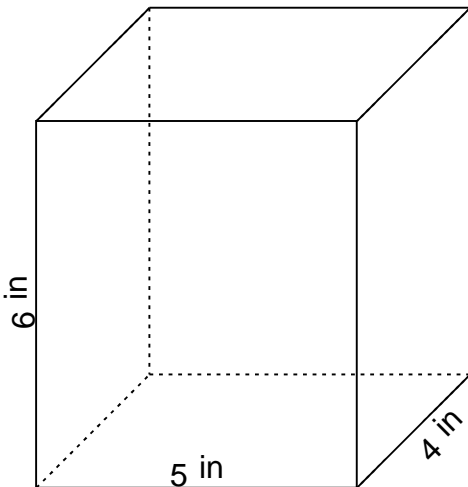

$$V = 120 \text{ in}^3 \quad SA = 148 \text{ in}^2$$

4.

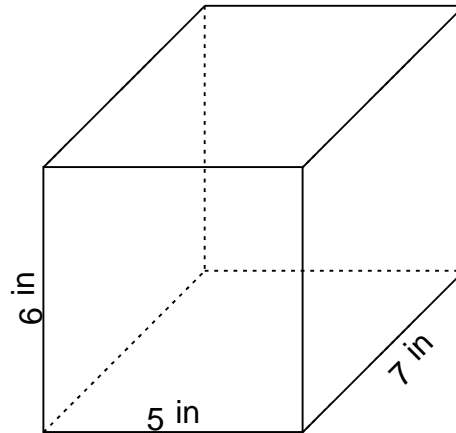

$$V = 210 \text{ in}^3 \quad SA = 214 \text{ in}^2$$